



Sagar[®]

ALUMINIUM EXTRUSION PVT. LTD.
AN ISO 9001:2015 CERTIFIED COMPANY

GET **SAE-POWERED** WITH YOUR
ALL-IN-ONE SOURCE FOR
ALUMINIUM EXTRUSION
SOLUTION

QUALITY IS THE
ULTIMATE
SOURCE OF SUCCESS

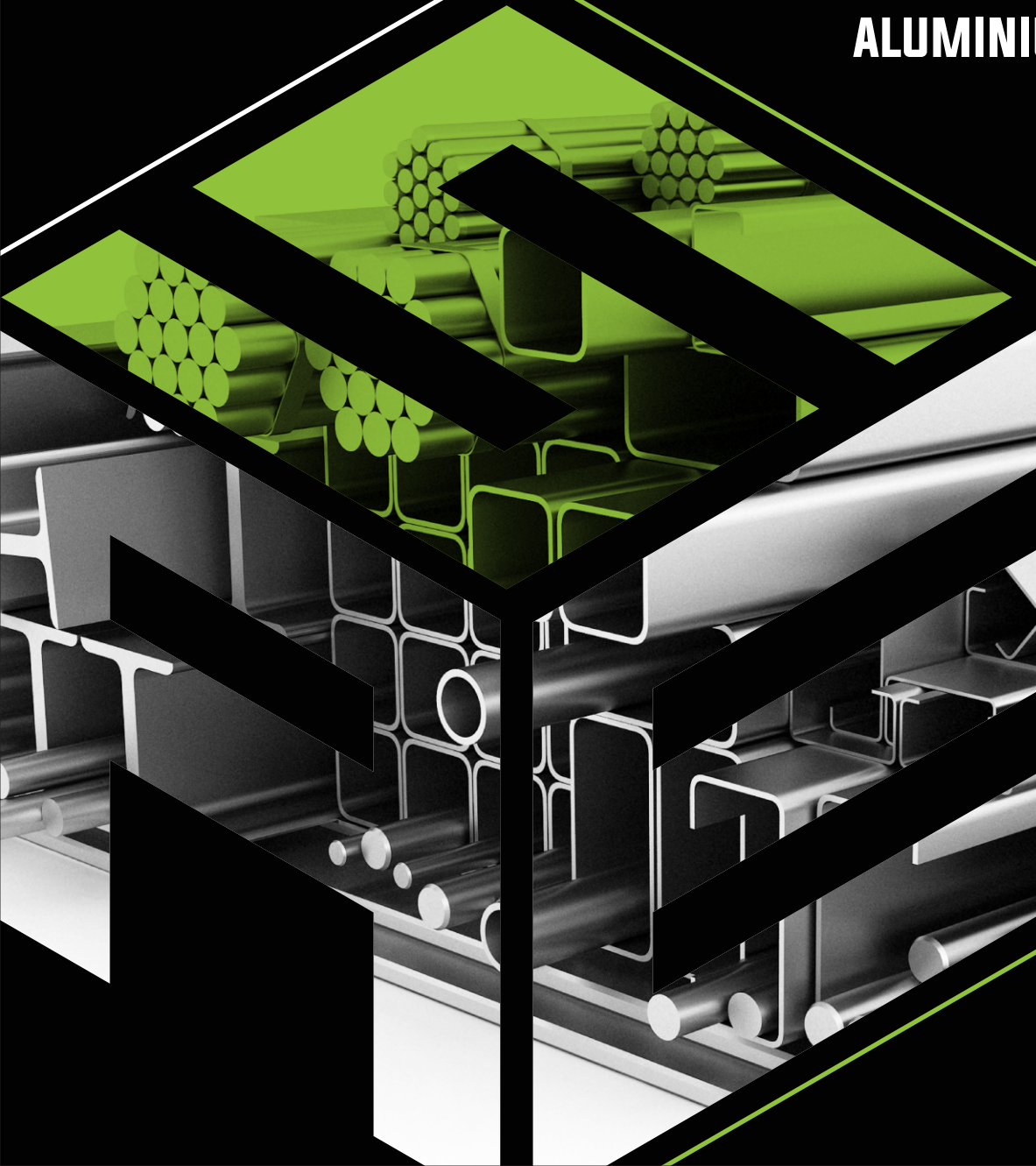



DELIVERING HIGH QUALITY



ABOUT COMPANY

Sagar Aluminium Extrusion has installed most modern extrusion plant of 1000 M.T. capacity and various other modern handling equipments to quality product.

We have in house foundry with modern melting furnace including fully Automatic HOT TOP casting Technology, we are able to produce high refined close grain with has uniform manner & oxide free on extrusion-surface. Raw material and Alloy are checked online using most modern spectrometer by keeping Alloy composition with in very close tolerance and achieving desired mechanical & chemical properties. The dies used in extrusion are made with latest tool room equipment which give us best quality.

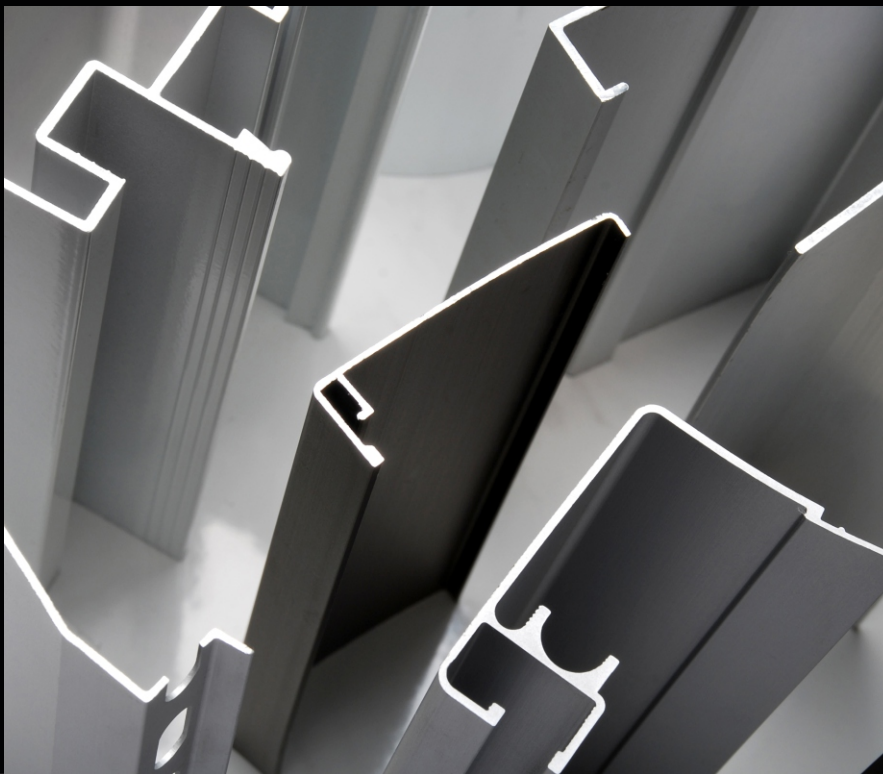



WHOLESALE SUPPLIER

Pioneering Wholesale Supplier: Providing premium Aluminium Sections and Profiles for diverse applications.

AFFORDABLE PRICE

With best product and service, You will get the best products in Affordable Prices compared to the world.

WIDE EXPERIENCE

We have skilled Persons that will fill their Experience to build your dream.

CREATIVE DESIGN

Providing best creative design and top notch solutions for the Aluminium Doors and Windows.

QUALITY IS THE
ULTIMATE
SOURCE OF SUCCESS



» OUR CORE VALUES

QUALITY & INNOVATION

Our driving forces, ensuring unwavering commitment to superior products and pioneering solutions."

SH-100

WEIGHT : 3.800-4.000kg/12'

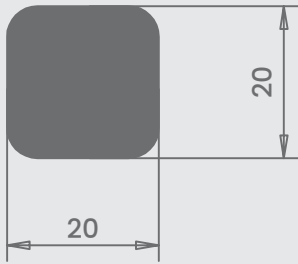

SH-101

WEIGHT : 6.000-6.500kg/12'



SH-102

WEIGHT : 4.800-5.200kg/12'

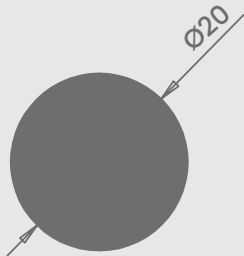

SH-103

WEIGHT : 5.000-5.600kg/12'

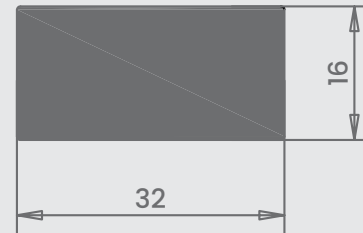

SH-104

WEIGHT : 3.900-4.300kg/12'

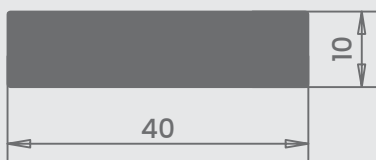

SH-105

WEIGHT : 2.300-2.500kg/12'

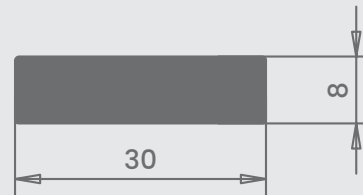

SH-106

WEIGHT : 2.000-2.200kg/12'

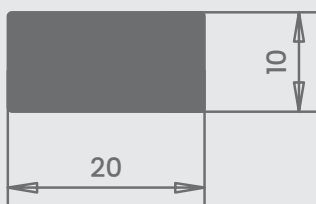

SH-107

WEIGHT : 3.700kg/12'

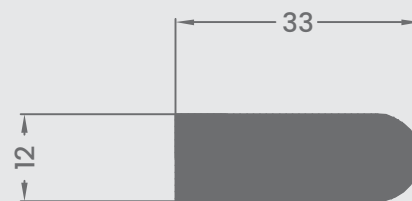

SH-108

WEIGHT : 2.600-2.800kg/12'

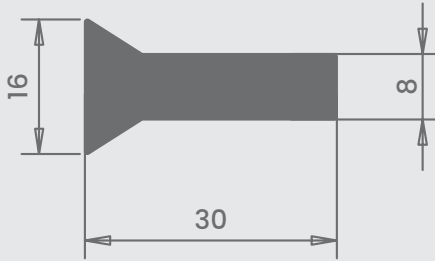

SH-109

WEIGHT : 2.200-2.400kg/12'

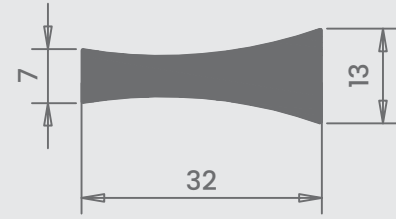

SH-110

WEIGHT : 2.900-3.300kg/12'

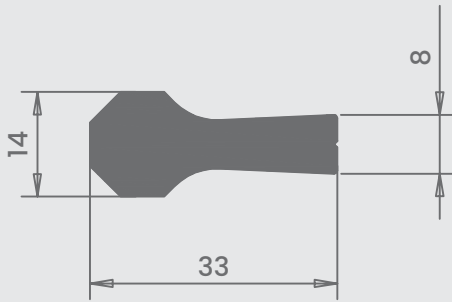

SH-111

WEIGHT : 2.800-3.200kg/12'

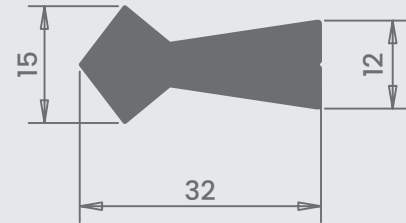

SH-112

WEIGHT : 3.100-3.500kg/12'

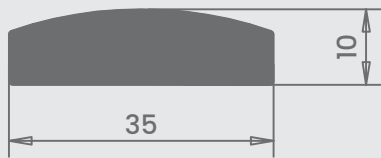

SH-113

WEIGHT : 3.300-3.700 KG/12'

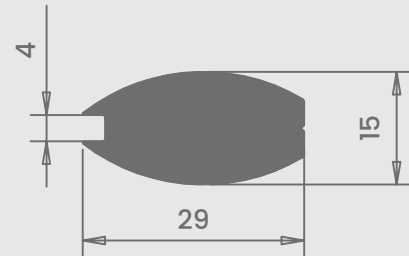

SH-114

WEIGHT : 1.900-2.300kg/12'

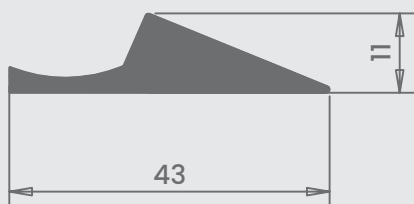

SH-115

WEIGHT : 1.400-1.600kg/12'

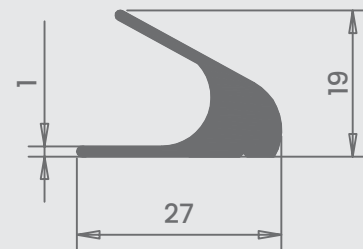

SH-117

WEIGHT : 0.280-0.320kg/12'

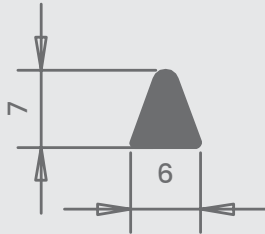

SH-118

WEIGHT : 3.500-3.800kg/12'



SH-119

WEIGHT : 2.100-2.500kg/12'

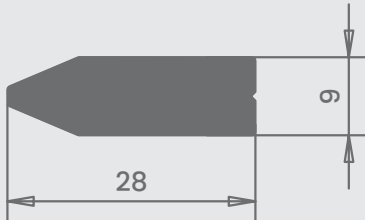

SH-120

WEIGHT : 2.350-2.550kg/12'

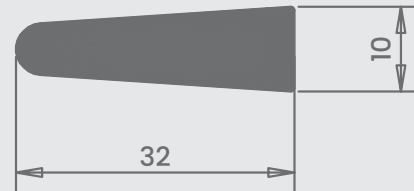

SH-121

WEIGHT : 1.900-2.300kg/12'

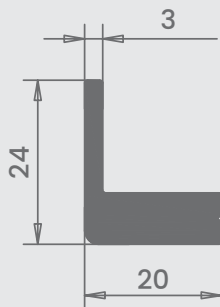

SH-122

WEIGHT : 1.750-1.950kg/12'

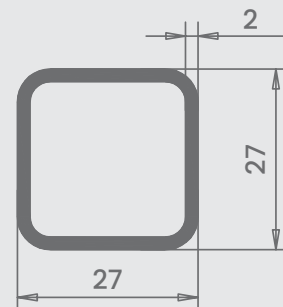

SH-123

WEIGHT : 5.900-6.400kg/12'

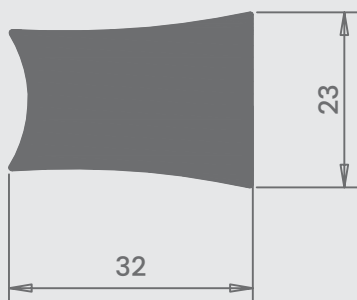

SH-124

WEIGHT : 1.600-1.900kg/12'

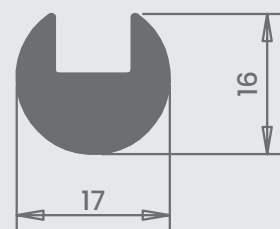

SH-125

WEIGHT : 4.750-4.950kg/12'

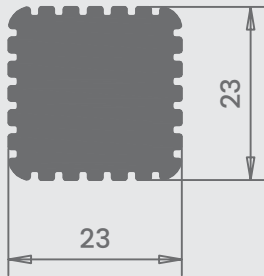

SH-126

WEIGHT : 2.800-3.200kg/12'

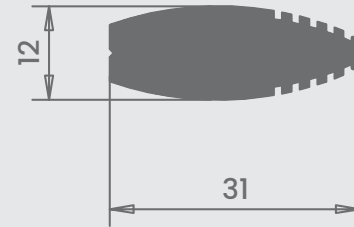

SH-127

WEIGHT : 3.350-3.650kg/12'

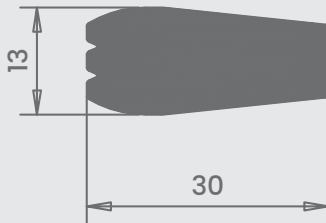

SH-128

WEIGHT : 1.800-2.200kg/12'

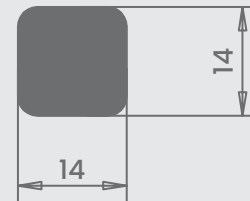

SH-129

WEIGHT : 1.800-2.200kg/12'

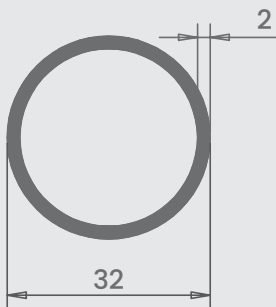

SH-130

WEIGHT : 1.000-1.200kg/12'

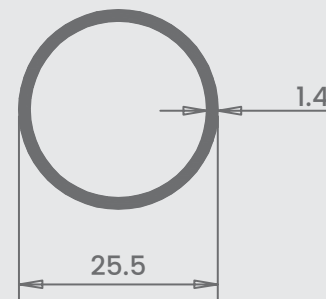

SH-131

WEIGHT : 7.900-8.400kg/12'

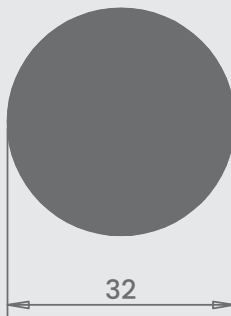

SH-132

WEIGHT : 2.200-2.600kg/12'

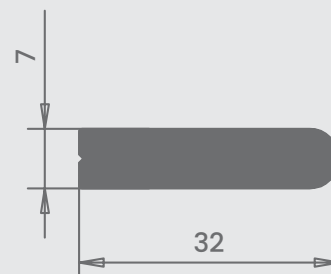

SH-133

WEIGHT : 2.300-2.700kg/12'

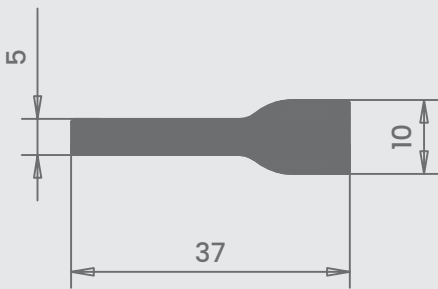

SH-134

WEIGHT : 2.400-2.600kg/12'

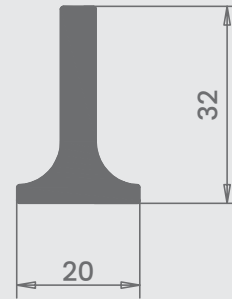

SH-135

WEIGHT : 1.900-2.100kg/12'

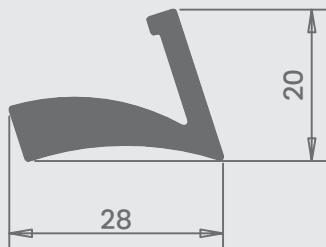

SH-136

WEIGHT : 2.300-2.500kg/12'

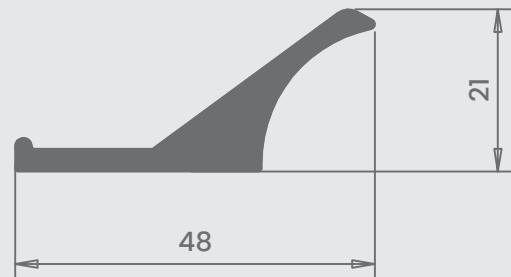

SH-138

WEIGHT : 2.250-2.550kg/12'

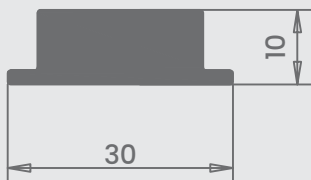

SH-139

WEIGHT : 3.000-3.400kg/12'

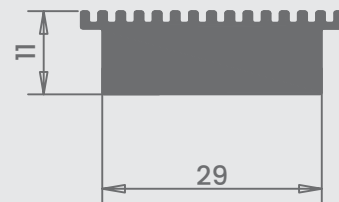

SH-140

WEIGHT : 3.600-4.000kg/12'



SH-141

WEIGHT : 1.650-1.950kg/12'

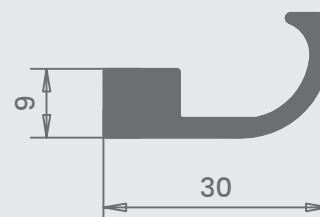

SH-137

WEIGHT : 13.900-14.200kg/12'

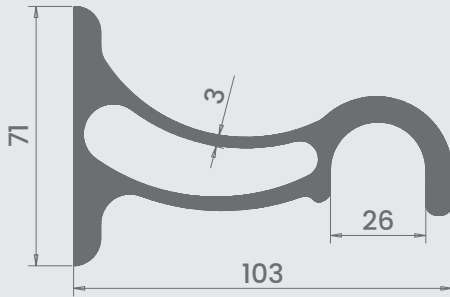

SH-142

WEIGHT : 10.100-10.700kg/12'

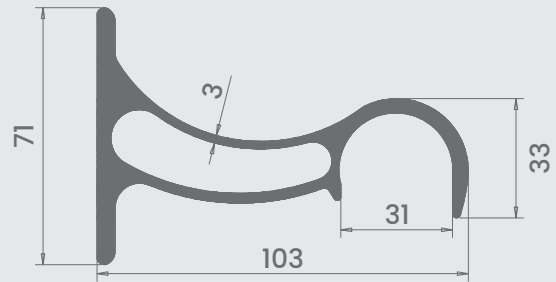

SH-144

WEIGHT : 5.800-6.000kg/12'

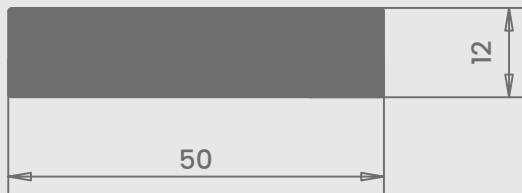

SH-145

WEIGHT : 9.500-10.000kg/12'

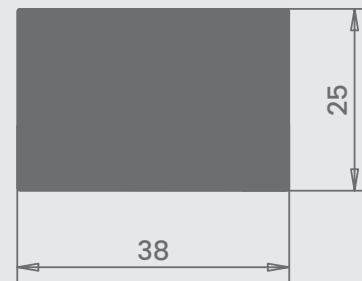

SH-146

WEIGHT : 2.700-2.900kg/12'



SH-147

WEIGHT : 1.950-2.150kg/12'

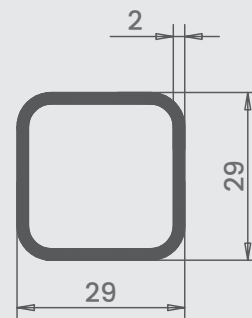

SH-148

WEIGHT : 3.200-3.400kg/12'

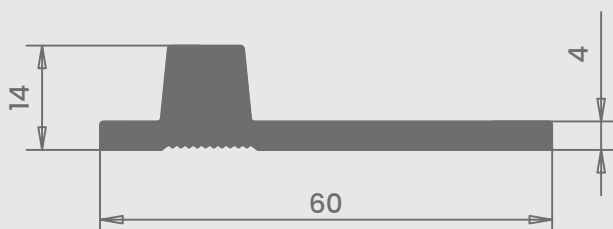

SH-149

WEIGHT : 1.000-1.200kg/12'

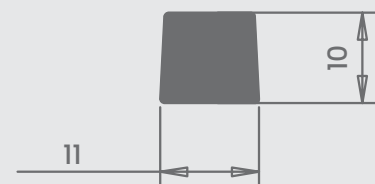

SH-150

WEIGHT : 2.850-2.150kg/1'

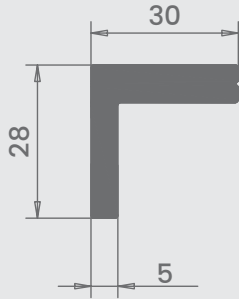

SH-151

WEIGHT : 5.300-5.500kg/12'

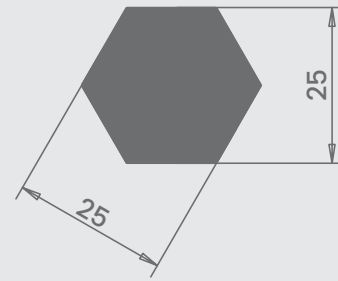

SH-152

WEIGHT : 8.500-8.900kg/12'

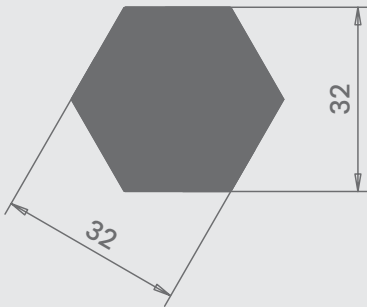

SH-153

WEIGHT : 3.000-3.500kg/12'

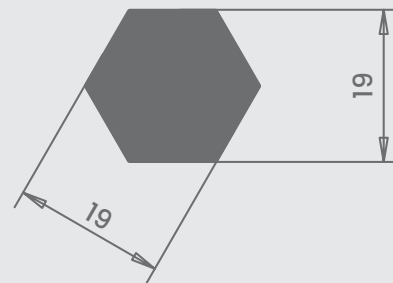

SH-154

WEIGHT : 1.600-1.800kg/12'

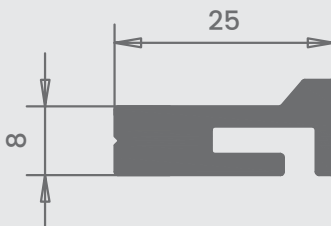

SH-155

WEIGHT : 0.550-0.850kg/12'

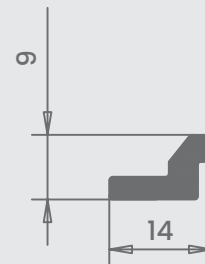

SH-156

WEIGHT : 4.300-4.500kg/12'

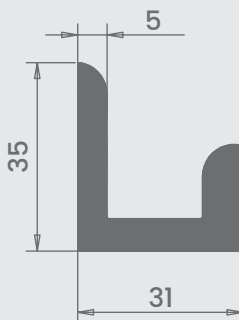

SH-157

WEIGHT : 3.000-3.200kg/12'

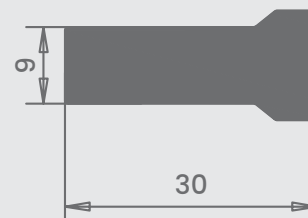

SH-158

WEIGHT : 2.900-3.100kg/12'

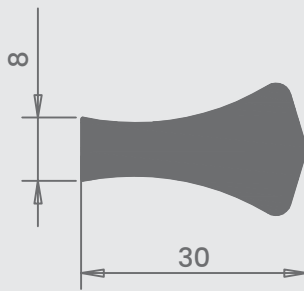

SH-159

WEIGHT : 0.900-1.100kg/12'

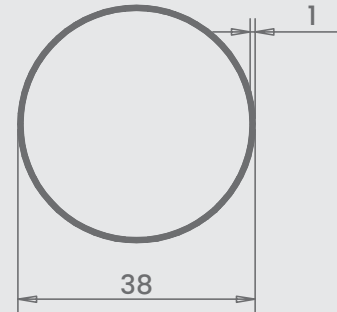

SH-160

WEIGHT : 1.900-2.100kg/12'

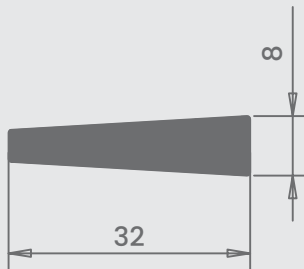

SH-161

WEIGHT : 2.500-2.700kg/12'

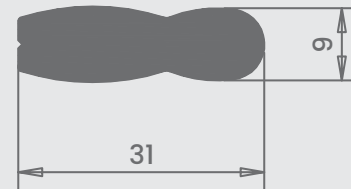

SH-162

WEIGHT : 2.700-2.900kg/12'

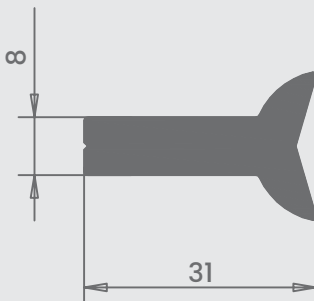

SH-163

WEIGHT : 1.000-1.200kg/12'

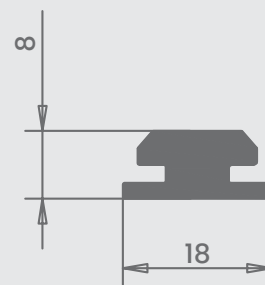

SH-164

WEIGHT : 2.600-2.800kg/12'

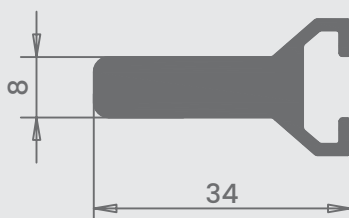

SH-165

WEIGHT : 2.629kg/12'

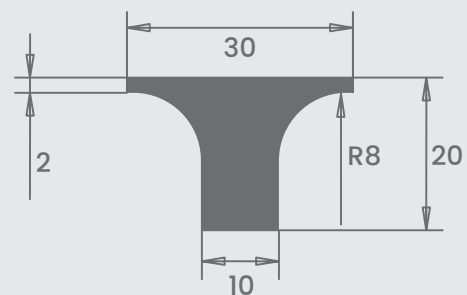

SH-166

WEIGHT : 1.027kg/12'

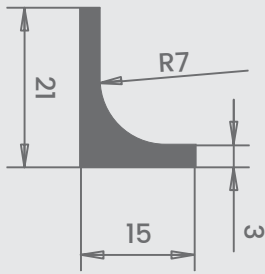

SP-167

WEIGHT : 1.450kg/12'

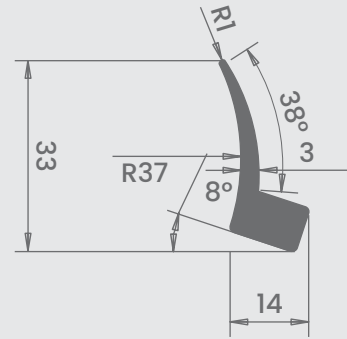

SH-168

WEIGHT : 3.214kg/12'

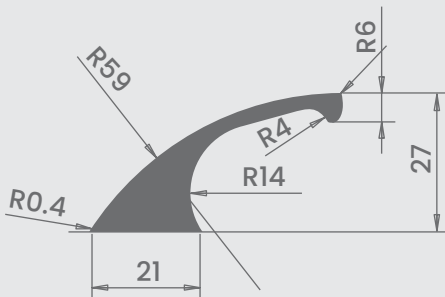

SH-169

WEIGHT : 1.725kg/12'

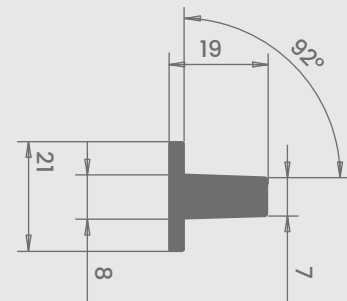

SH-170

WEIGHT : 5.599kg/12'

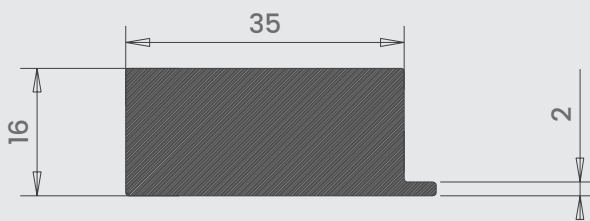

SH-172

WEIGHT : 3.247kg/12'

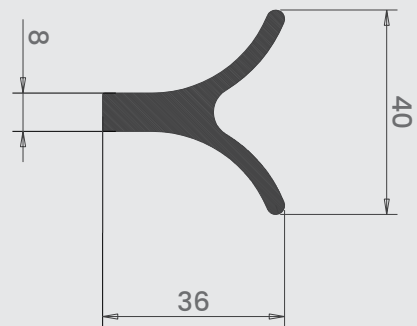

SH-174

WEIGHT : 0.990kg/12'

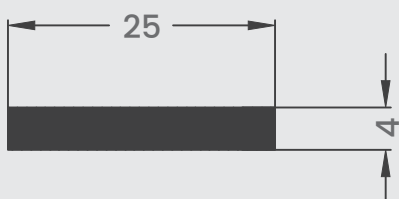

SH-175

WEIGHT : 1.990kg/12'

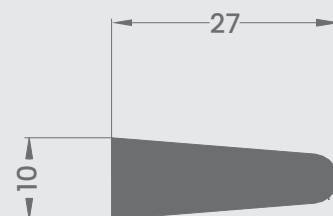

SH-176

WEIGHT : 3.740kg/12'

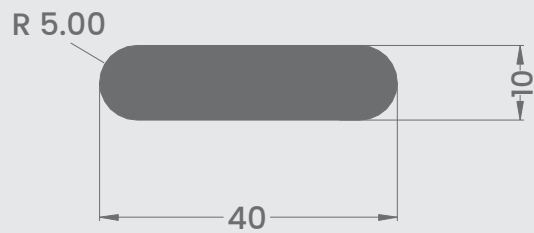

SH-177

WEIGHT : 2.200kg/12'

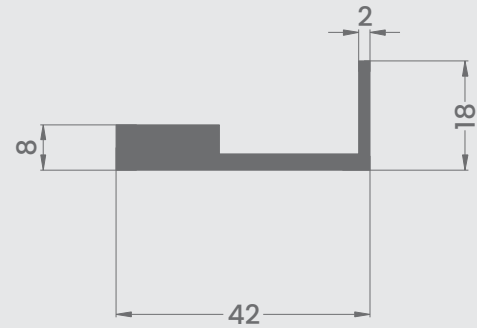

SH-178

WEIGHT : 2.930kg/12'

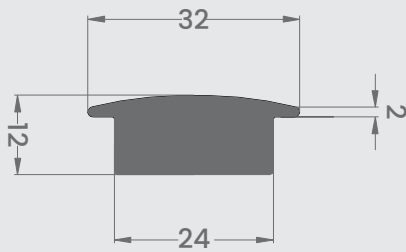

SP-200

WEIGHT : 1.00-1.150kg/10'

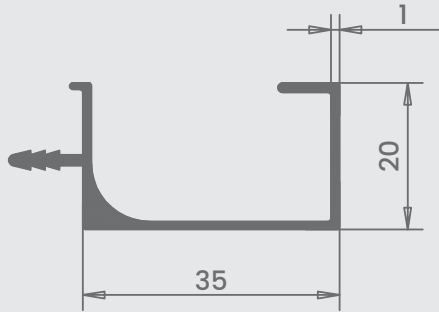

SP-201

WEIGHT : 1.200-1.360kg/10'

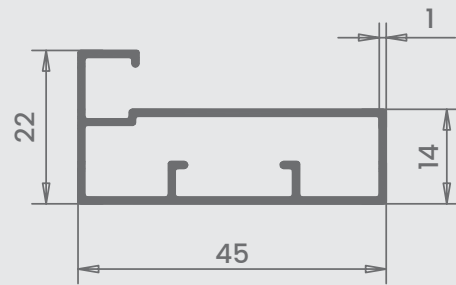

SP-202

WEIGHT : 1.60-1.70kg/10'

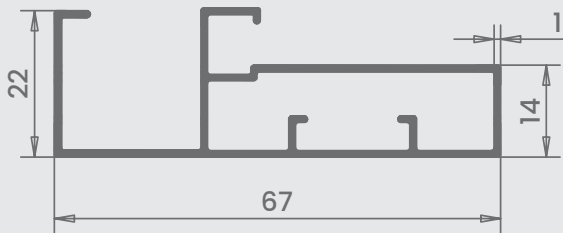

SP-203

WEIGHT : 1.100-1.200kg/10'

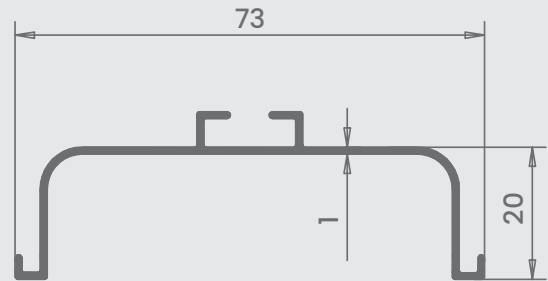

SP-204

WEIGHT : 0.850-0.950kg/10'

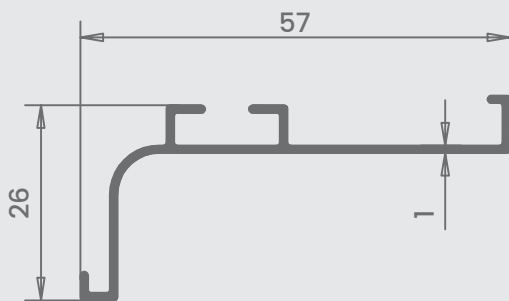

SP-205

WEIGHT : 1.250-1.350kg/10'

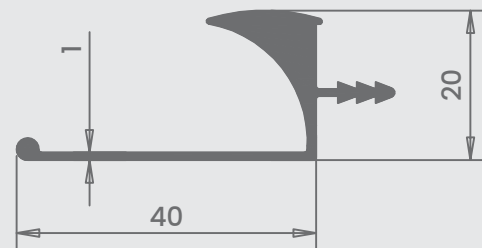

SP-206

WEIGHT : 1.400-1.500kg/10'

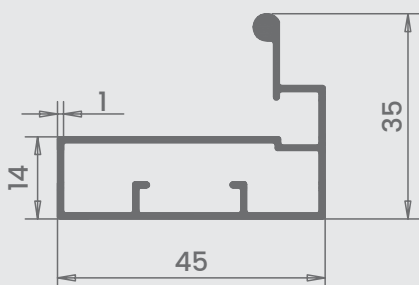

SP-207

WEIGHT : 1.200-1.300kg/10'

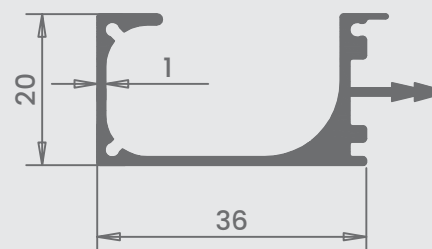

SP-208

WEIGHT : 1.550-1.650kg/10'

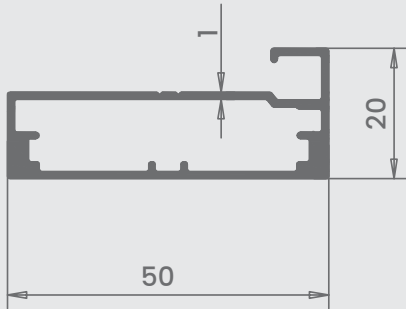

SP-209

WEIGHT : 1.750-1.850kg/10'

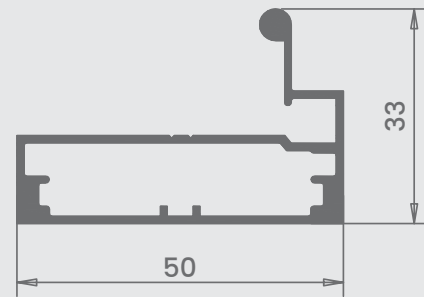

SP-210

WEIGHT : 0.850-0.950kg/10'

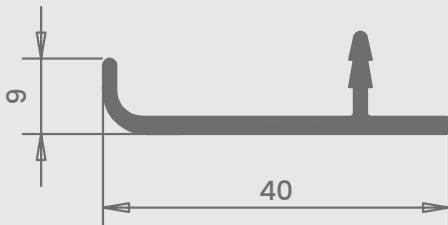

SP-211

WEIGHT : 0.900-1.00kg/10'

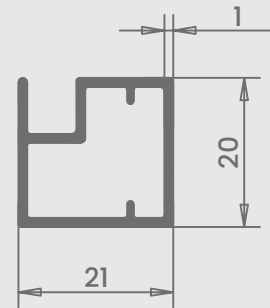

SP-212

WEIGHT : 1.100-1.250kg/10'

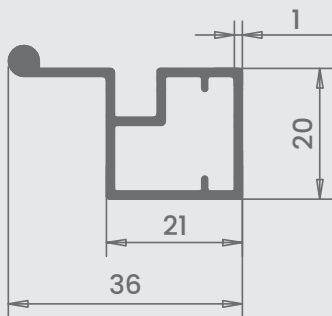

SP-213

WEIGHT : 0.900-1.00kg/10'

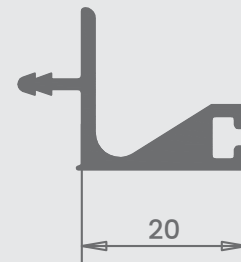

SP-214

WEIGHT : 1.200-1.300kg/10'

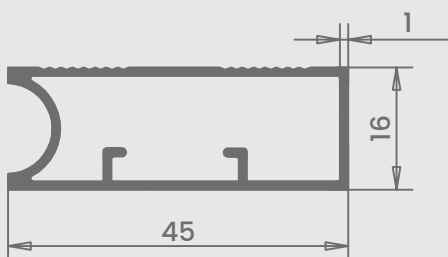

SP-215

WEIGHT : 2.00-2.200kg/10'

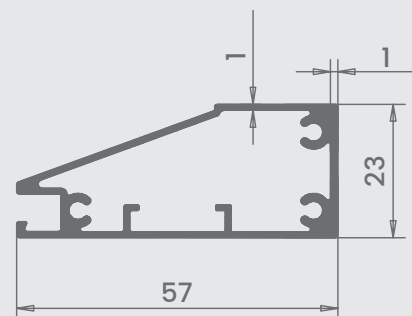

SP-217

WEIGHT : 1.250-1.350kg/10'

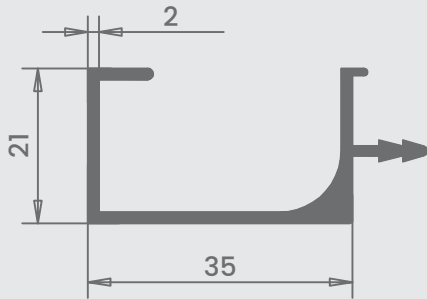

SP-221

WEIGHT : 1.350-1.550kg/12'

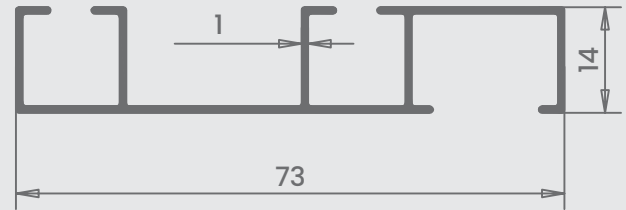

SP-222

WEIGHT : 0.950-1.150kg/12'

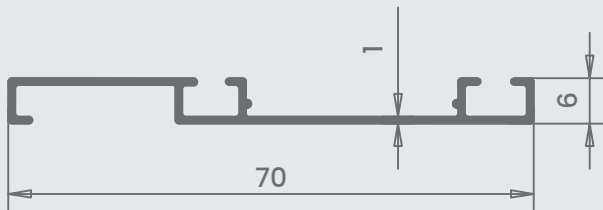

SP-223

WEIGHT : 0.300-0.500kg/12'

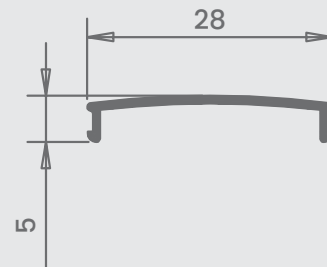

SP-224

WEIGHT : 1.100-1.300kg/12'



SP-225

WEIGHT : 1.100-1.300kg/12'

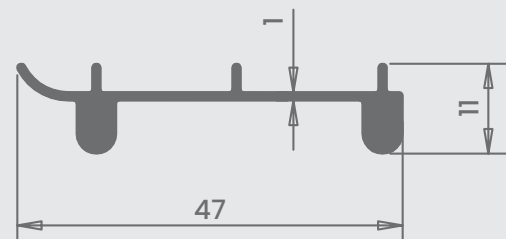

SP-226

WEIGHT : 2.500-2.700kg/12'

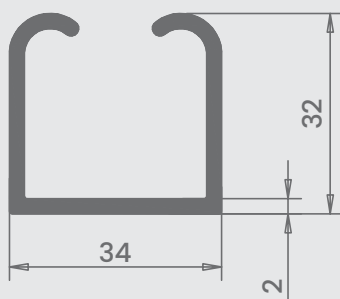

SP-231

WEIGHT : 0.100-0.110kg/10'

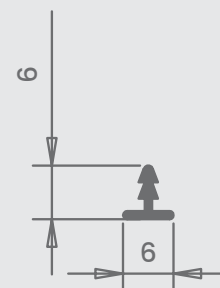

SP-232

WEIGHT : 0.100-0.120kg/10'

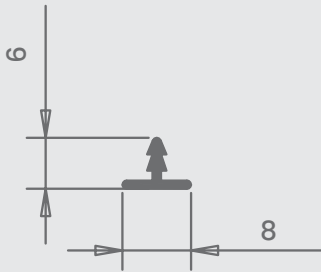

SP-233

WEIGHT : 0.130-0.140kg/10'

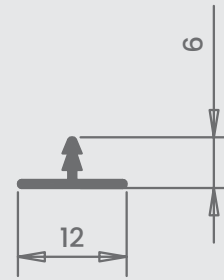

SP-234

WEIGHT : 0.300-0.400kg/10'

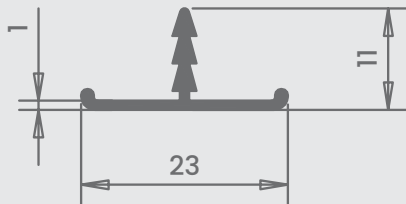

SP-250

WEIGHT : 1.300-1.500kg/12'

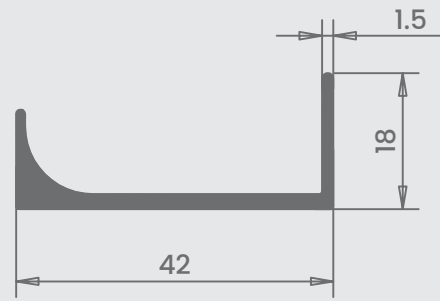

SP-251

WEIGHT : 1.150-1.350kg/12'

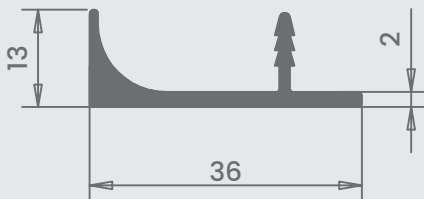

SP-252

WEIGHT : 1.400-1.600kg/12'

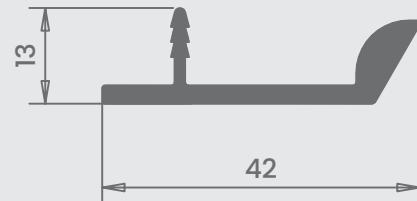

SP-253

WEIGHT : 1.500-1.700kg/12'

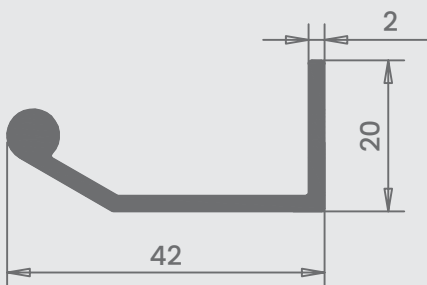

SP-254

WEIGHT : 2.300-1.500kg/12'

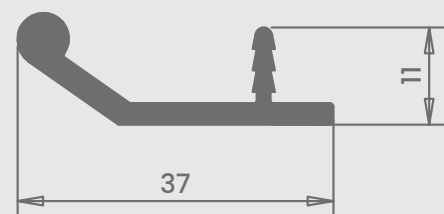

SP-255

WEIGHT : 1.600-1.800kg/12'

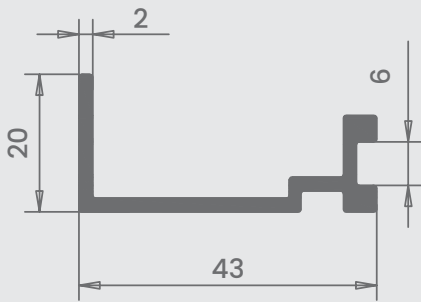

SP-256

WEIGHT : 1.350-1.550kg/12'

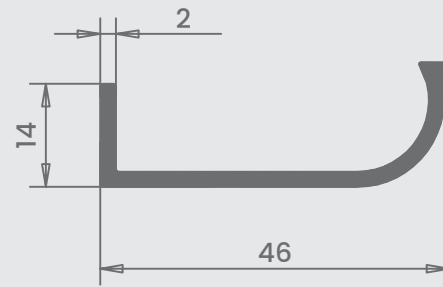

SP-257

WEIGHT : 1.200-1.400kg/12'

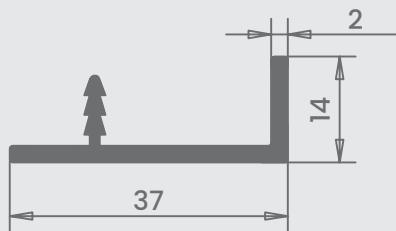

SP-258

WEIGHT : 1.200-1.400kg/12'

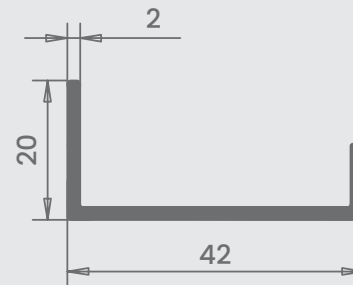

SP-259

WEIGHT : 1.500-1.700kg/12'

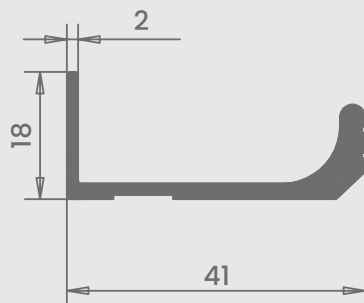

SP-260

WEIGHT : 1.250-1.450kg/12'

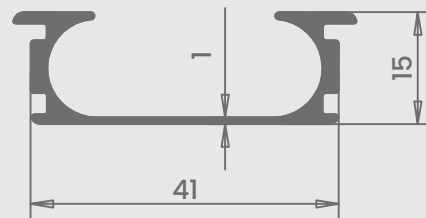

SP-261

WEIGHT : 1.800-2.00kg/12'

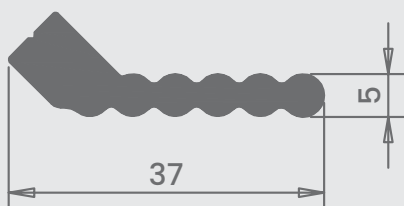

SP-262

WEIGHT : 1.100-1.300kg/12'

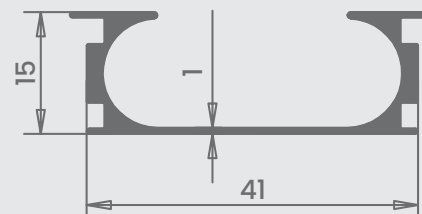

SP-263

WEIGHT : 1.350-1.550kg/12'

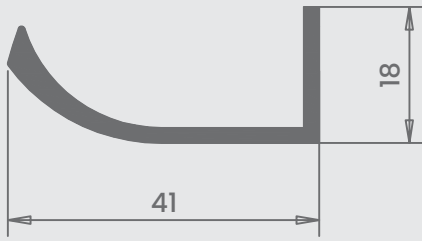

SP-264

WEIGHT : 1.300-1.500kg/12'

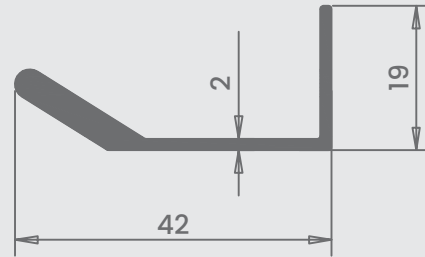

SP-265

WEIGHT : 1.200-1.400kg/12'

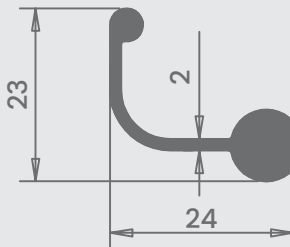

SP-266

WEIGHT : 0.900-1.100kg/12'

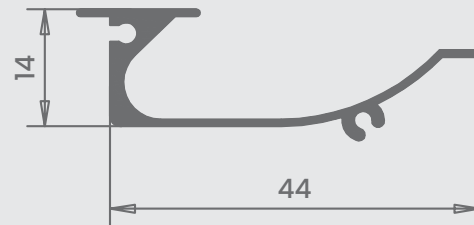

SP-267

WEIGHT : 1.0373kg/12'

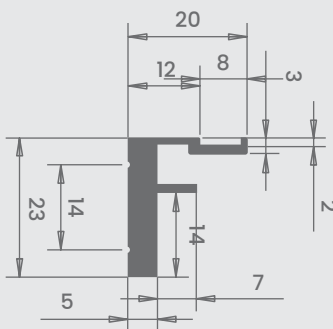



GET **SAE-POWERED** WITH YOUR
ALL-IN-ONE SOURCE FOR
ALUMINIUM EXTRUSION
SOLUTION



SAGAR ALUMINIUM EXTRUSION PRIVATE LIMITED

- REG. OFFICE ADDRESS : Plot No. 16,17,24,25, Sur. No. 1013p, Kaneriya Industrial Zone, Vill- Khambha, Tal- Lodhika, Dist- Rajkot, Rajkot- 360035, Gujarat, India
- +91 99989 00536
- info@sagaraluminiumextrusion.com
- www.sagaraluminiumextrusion.com